

Plastic Frame Speaker

Model: OSAE57S-11P0.5W16



ELECTRICAL SPECIFICATIONS

	Condition	Parameter	Unit
Sound Pressure Level	at 0.1W, 0.1M [at 1KHz]	89 ± 3	dB
Impedance	at 1V, 1000Hz	16 ± 15%	Ω
Rated Input Power		0.5	W
Max Input Power		1	W
Resonant Frequency (Fo)	at 1V	500 ± 20%	Hz
Frequency Range		Fo ~ 20000	Hz
Buzzer & Rattles	not be audible at sine wave between 150 ~ 3KHz	2.82	V
Operating Temperature		-20 ~ 60	°C
Magnet		Ferrite	
Frame Material		Plastic	
Cone Material		Paper	
Weight		15	g

MECHANICAL DRAWING

Dimensions in mm

Tolerance ±0.5mm Except Specified

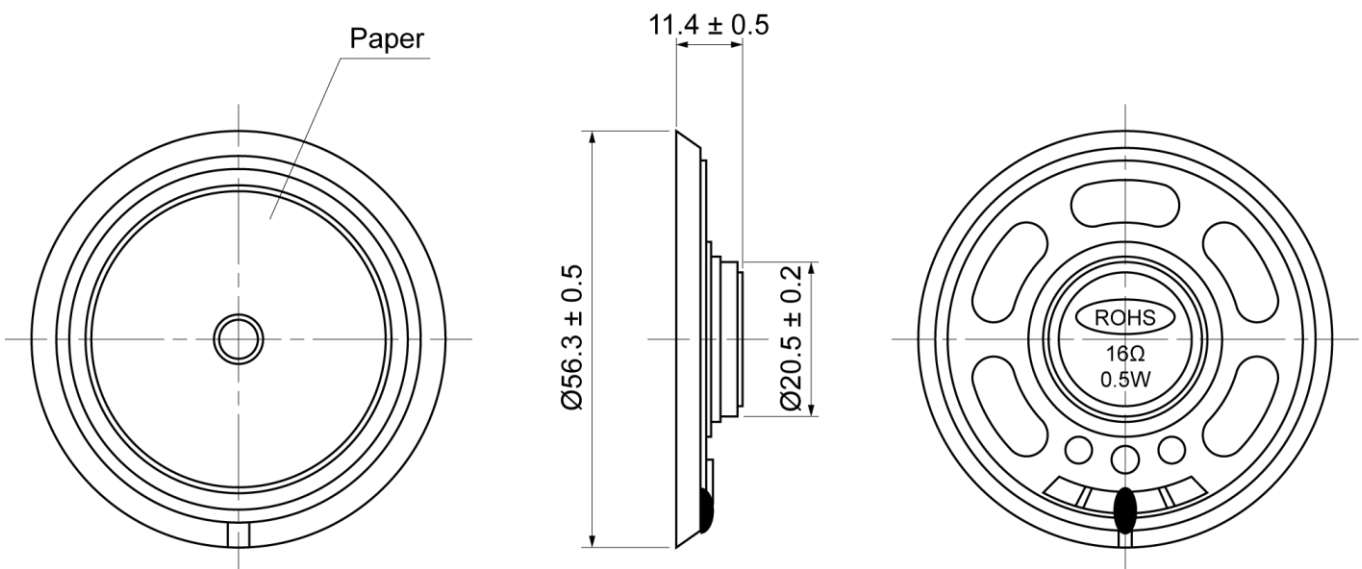

Plastic Frame Speaker

Model: OSAE57S-11P0.5W16

FREQUENCY RESPONSE CURVE

